

*Ministère de l'Éducation Nationale,
de l'Enseignement Supérieur et de la Recherche*

Circonscription Lille 1– Centre Académie de Lille

Nom :

Prénom :

Date de naissance :/...../ 20

Evaluation début CP

Année scolaire	Niveau	Enseignant - école
2015-2016	CP	

EPREUVE 1

Graphisme

ITEM 1

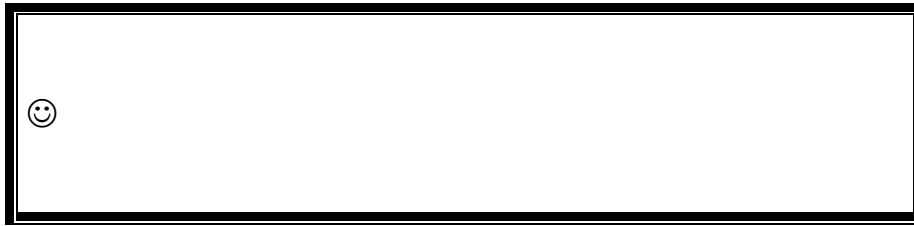





ITEM 2

Copie

.maman est jolie.

ITEM 3

	<p>. lune</p>		<p>. lapin</p>
	<p>.</p>		<p>.</p>

	<p>. bateau</p>
	<p>.</p>

EPREUVE 2

Langage technique

ITEM 1

a e 2 c ?

ITEM 2

3 6 b , +

ITEM 3

7 où m ☆ + ? île

ITEM 4

123 ☀ soleil §qpbdm

ITEM 5

je vais à l'école

ITEM 6

Arthur mange des galettes.

ITEM 7

34295 abcdef428 fille Le chat dort.

ITEM 8

Le chat dort sur le coussin.

Item 9

arbre chien flûte

Discrimination visuelle (1)

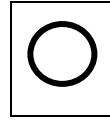
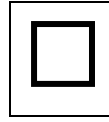
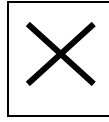
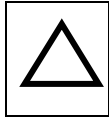

h

4

n

μ

n

h

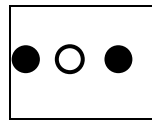
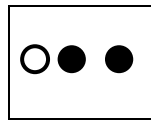
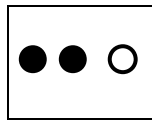
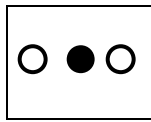
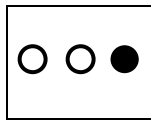
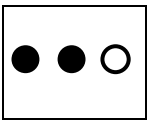

36

93

36

ε6

39

63

963

369

693

96ε

963

936

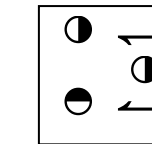
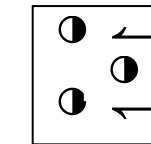
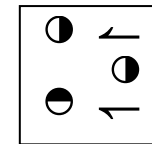
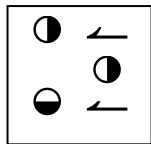
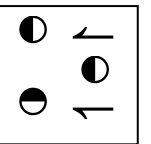
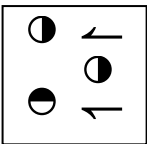

EPREUVE 4

Discrimination visuelle (2)

ITEM 1

ours	suro	ousr	ours	uors	rous
------	------	------	------	------	------

ITEM 2

lapin	lutin	lapon	lupin	lapin	latin
-------	-------	-------	-------	-------	-------

ITEM 3

vélo	Mon frère fait du vélo dans la cour.
------	--------------------------------------

Conscience phonologique (1)

ITEM 1

1

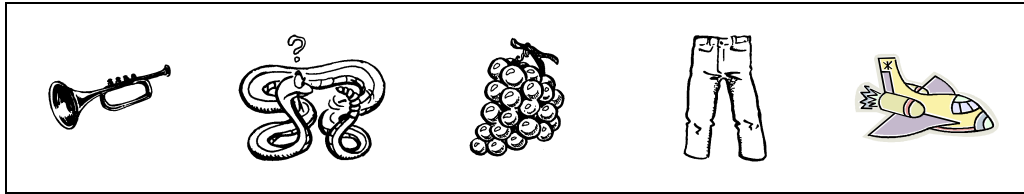

ITEM 2

2

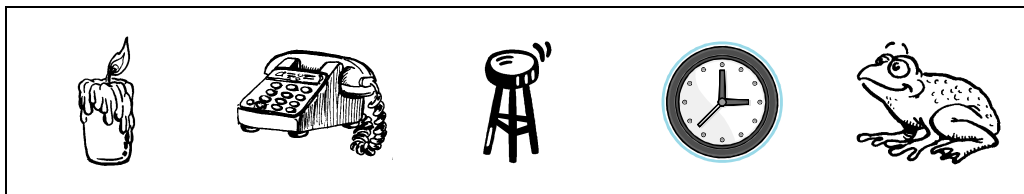



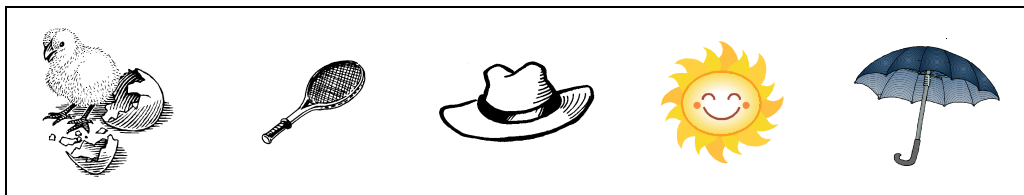

ITEM 3

3

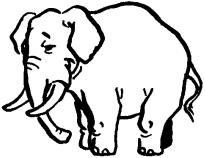

ITEM 4

		
○ ○ ○ ○	○ ○ ○ ○	○ ○ ○ ○
		
○ ○ ○ ○	○ ○ ○ ○	○ ○ ○ ○

Conscience phonologique (2)

ITEM 1

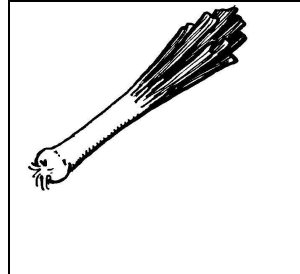
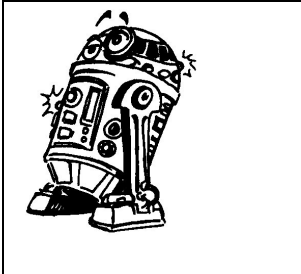

--	--

--	--

--	--	--

ITEM 2

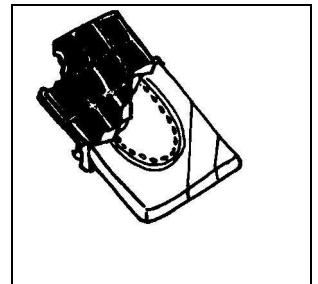
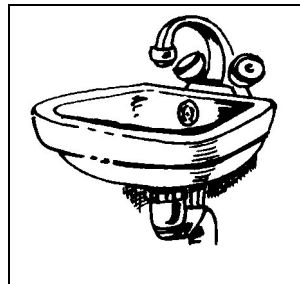
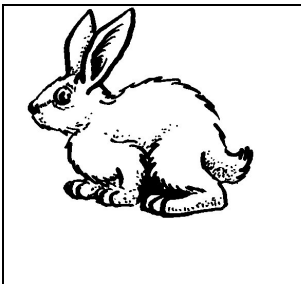

--	--

--	--	--

--	--	--

ITEM 3

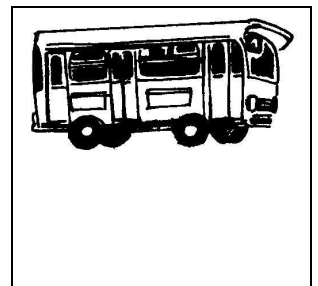
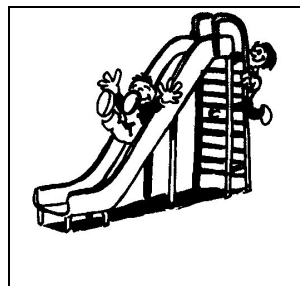
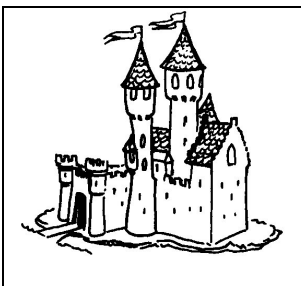

--	--

--	--	--

--	--	--

Conscience phonologique (3)

ITEM 1



ITEM 2

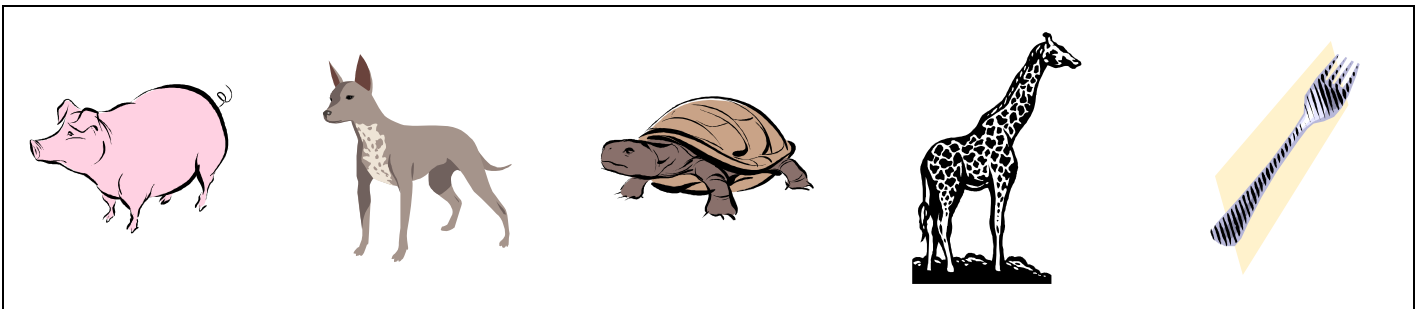

ITEM 3

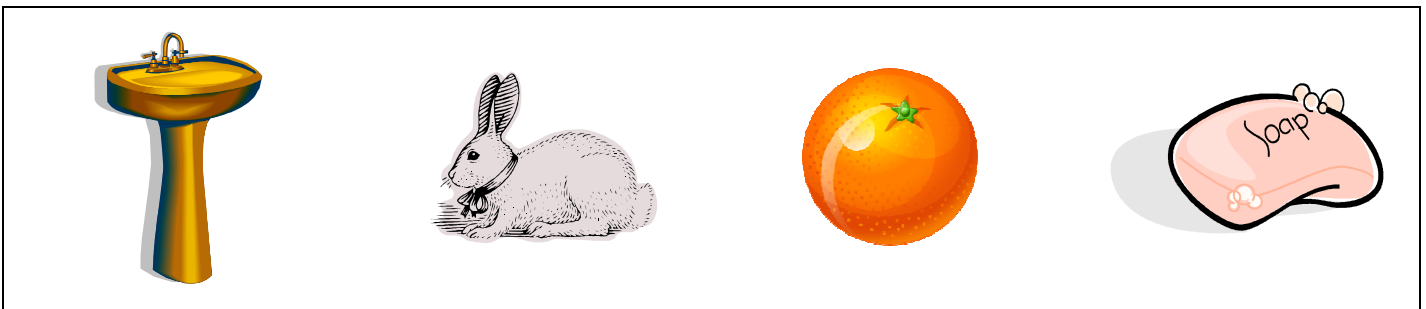

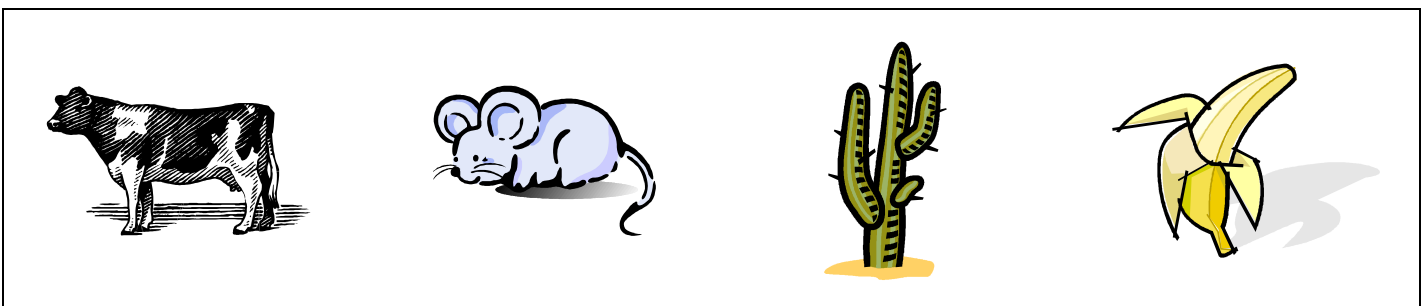

ITEM 4



Productions d'écrits

ITEM 1

	un _____
---	----------

	une _____
---	-----------

	une _____
--	-----------

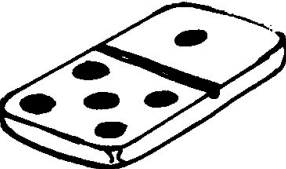
	un _____
---	----------

ITEM 2

	_____
---	-------

ITEM 3

	1 2 3 4 5 6
---	--------------------------------------

	1 2 3 4 5 6
---	--------------------------------------

Compréhension d'histoire 1

ITEM 1

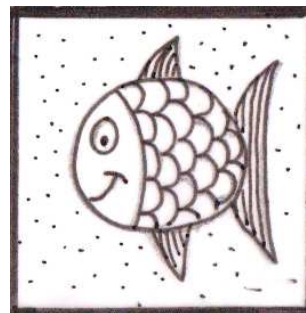
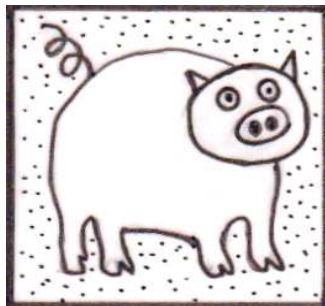
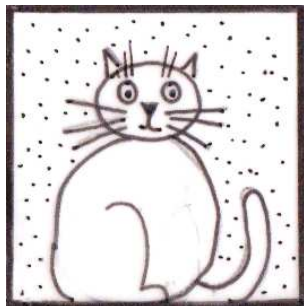

ITEM 2

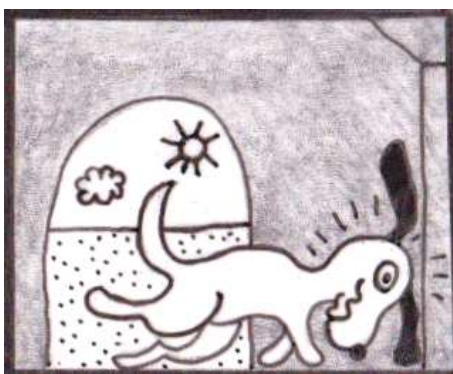

ITEM 3

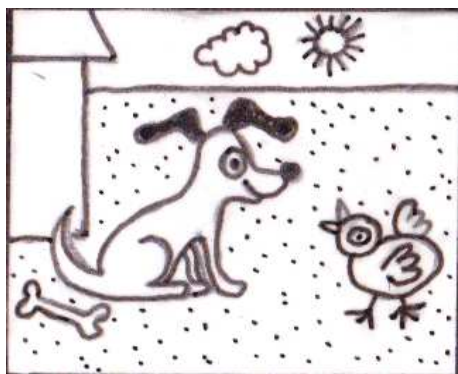

ITEM 4



Compréhension d'histoire 2

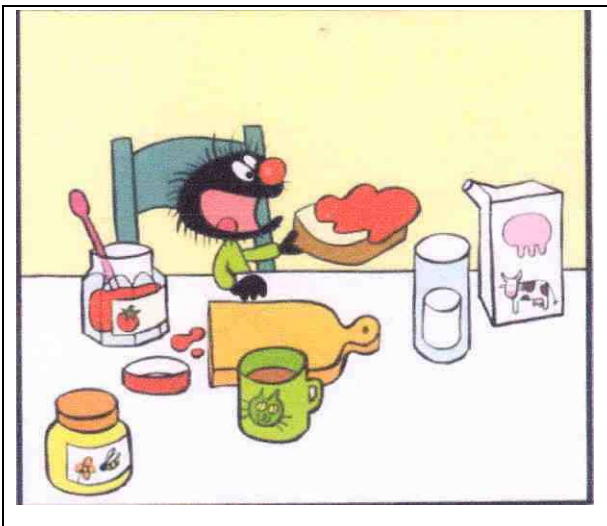
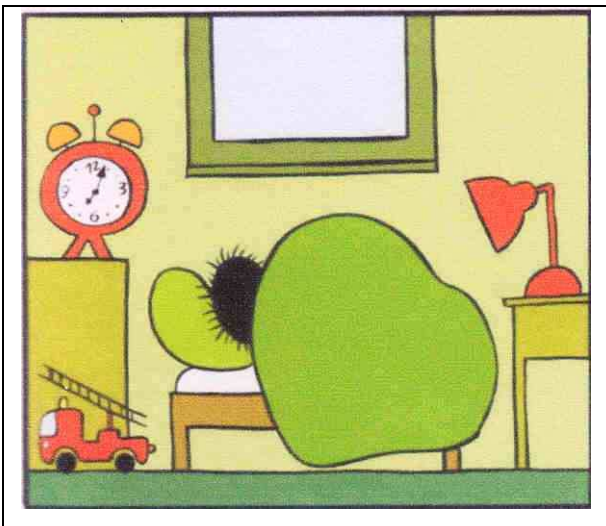
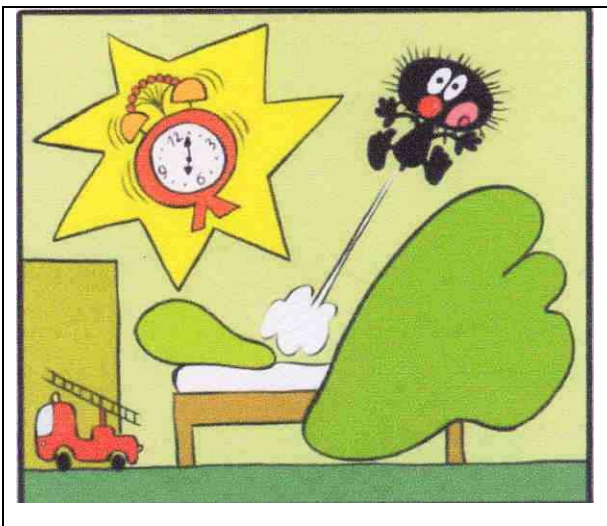
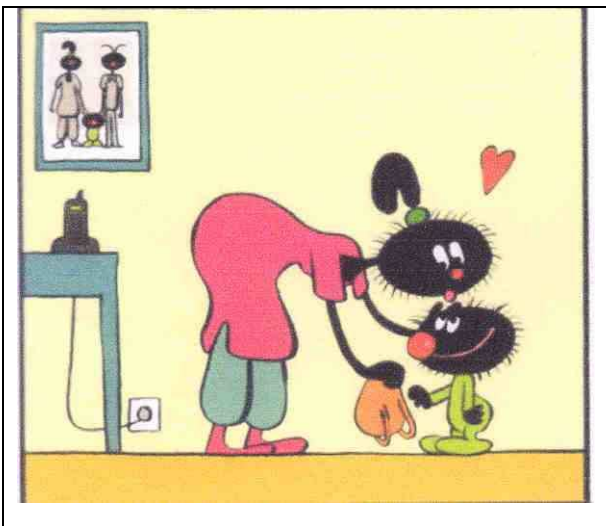

Productions d'écrit

ITEM 1

co

pain

bou

chon



ITEM 2

la

pin

cer

ceau

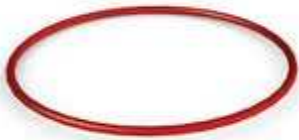
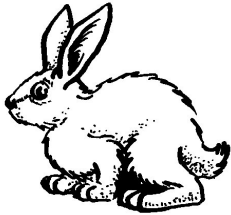

ITEM 3

ra

teau

cha

meau

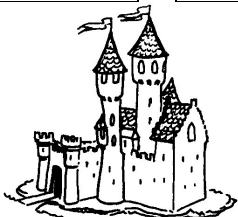
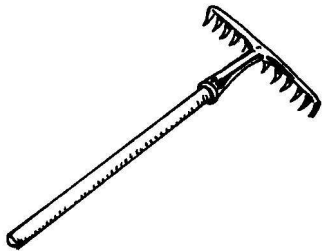

Compréhension orale

ITEM 1

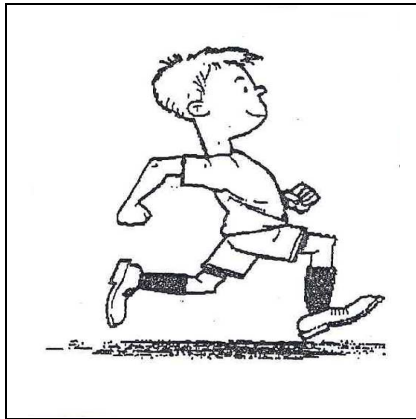
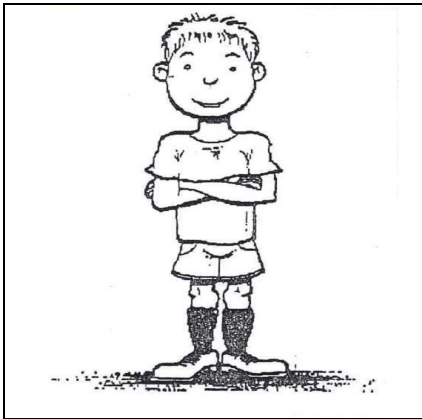
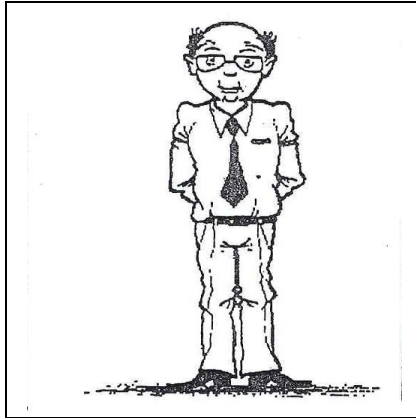
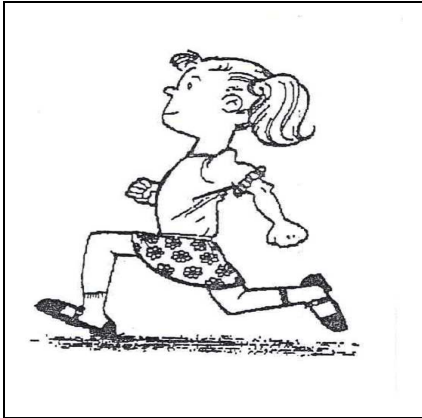

ITEM 2

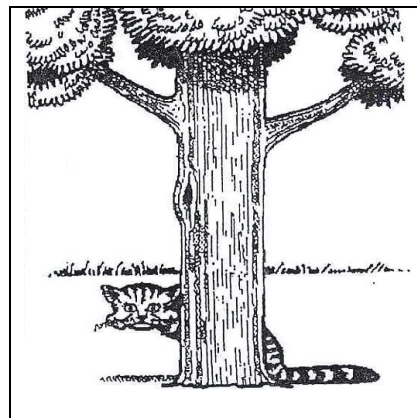
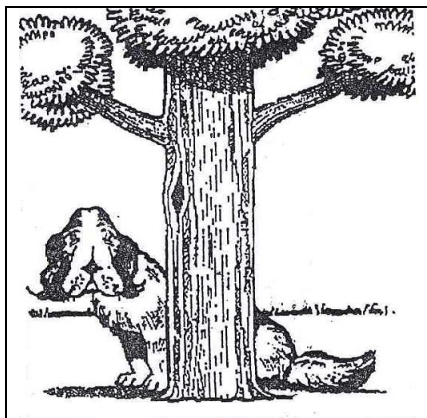
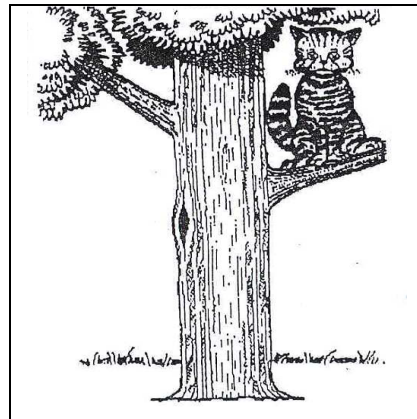
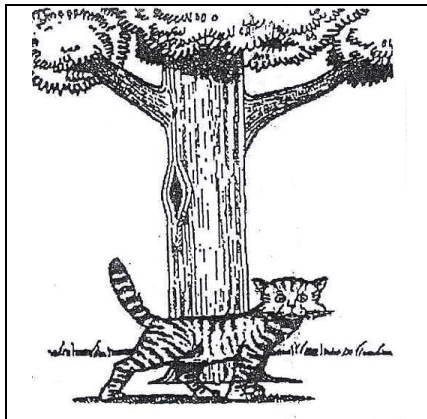

ITEM 3

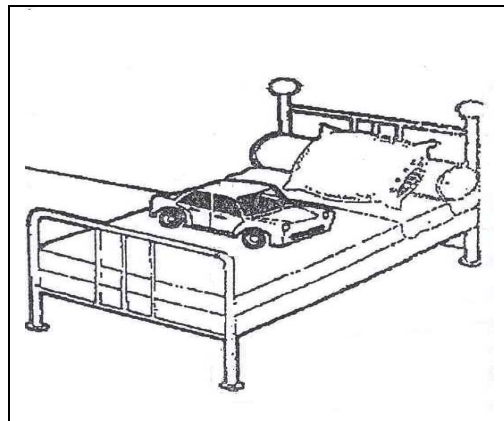
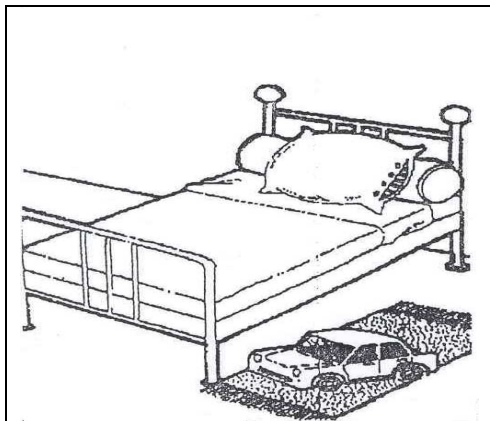
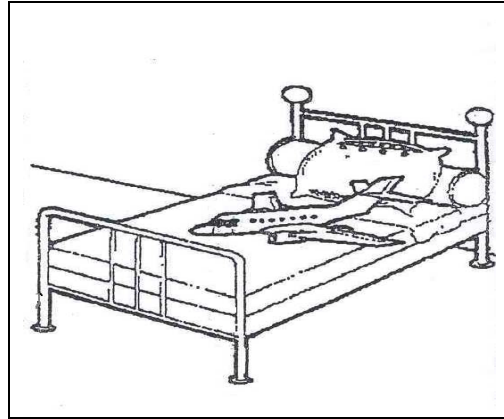
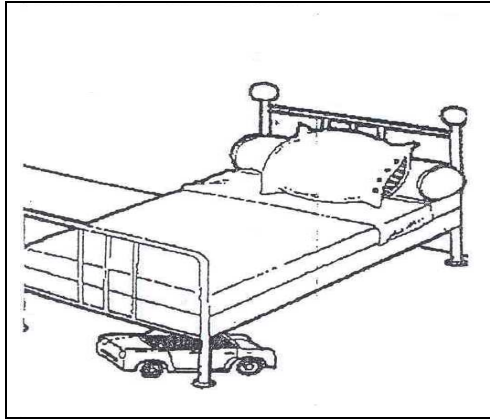

ITEM 4

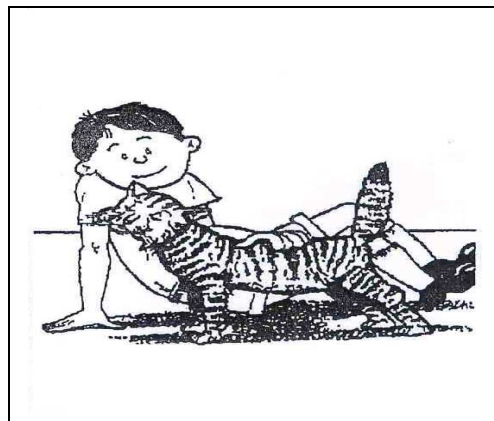
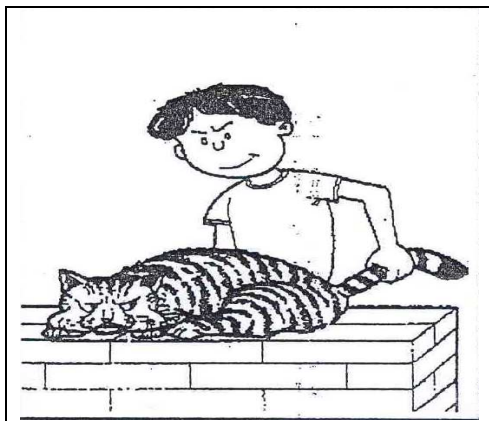
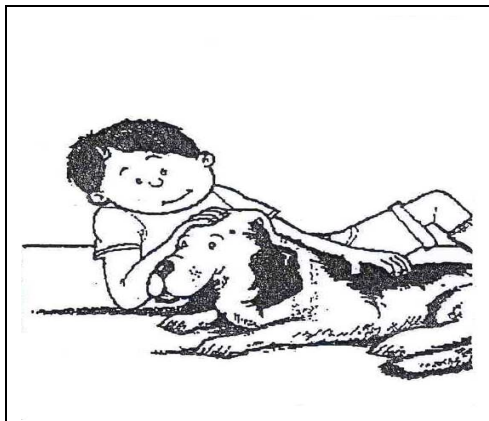

ITEM 5

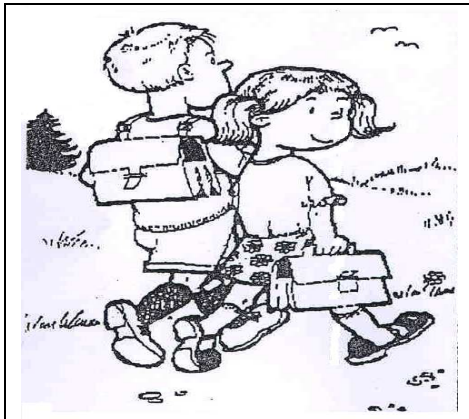
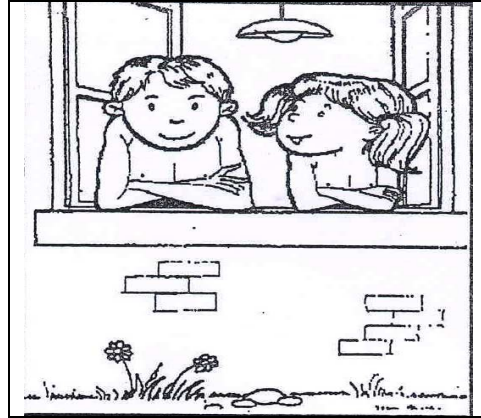

ITEM 6

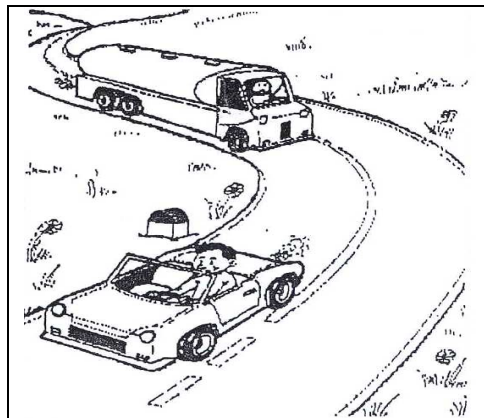
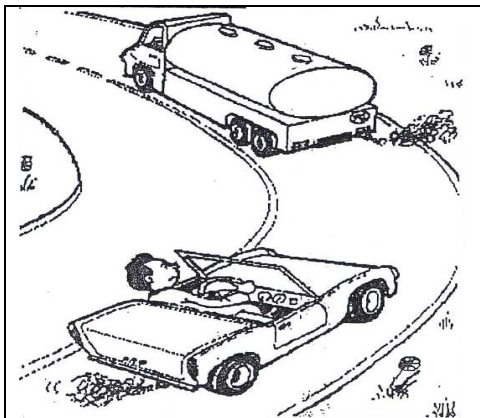
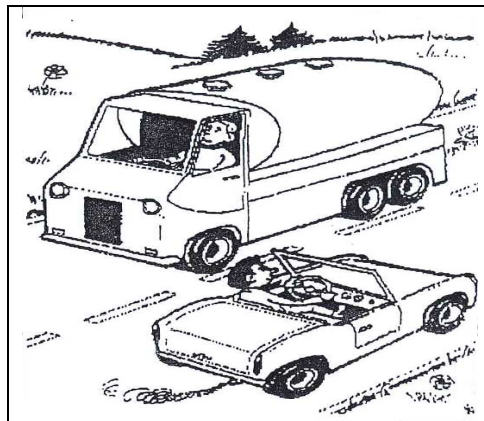
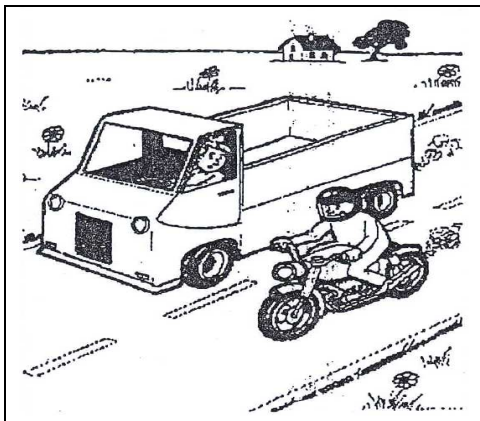

ITEM 7

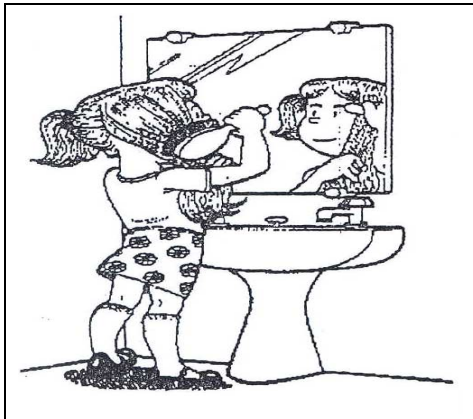
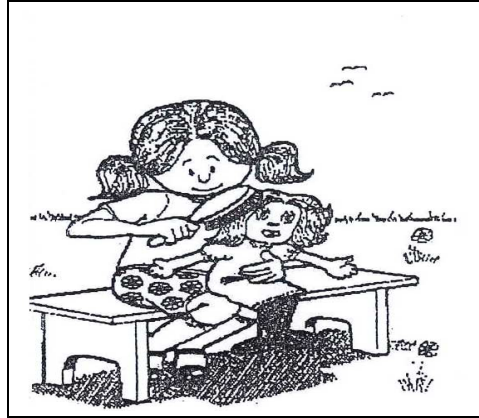

ITEM 8

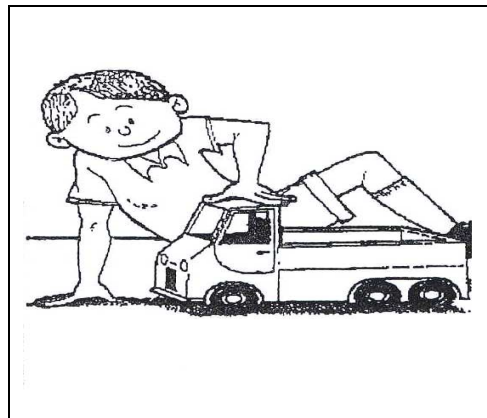
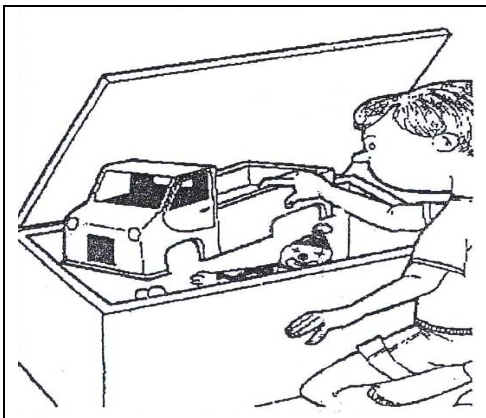
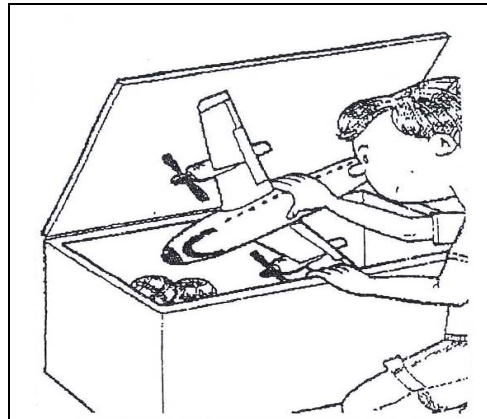
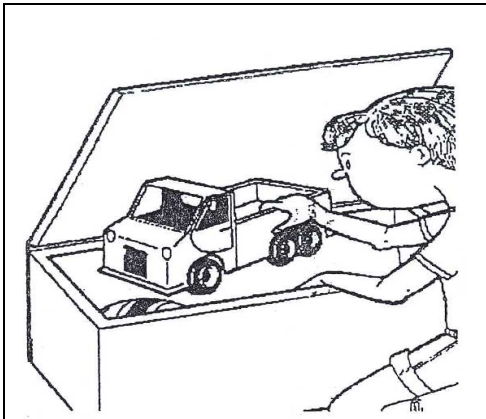

ITEM 9

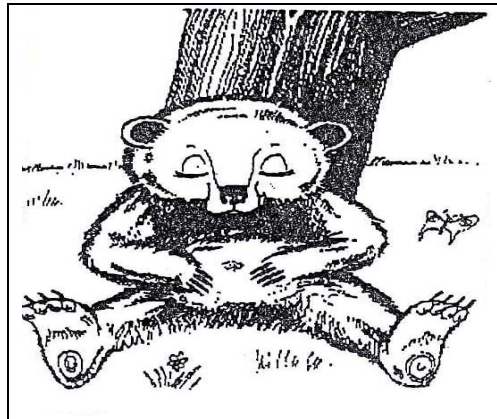
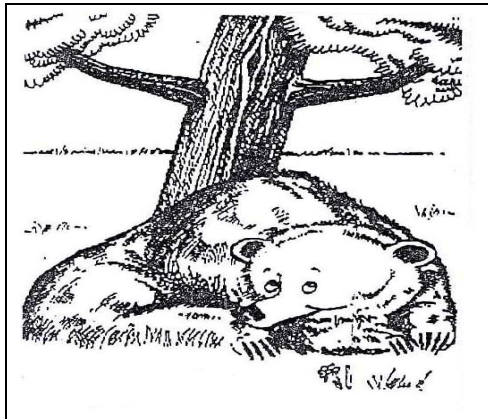
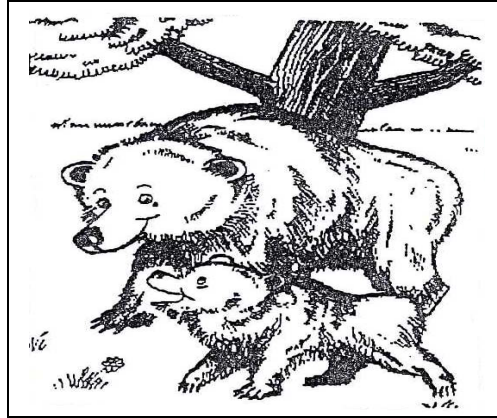
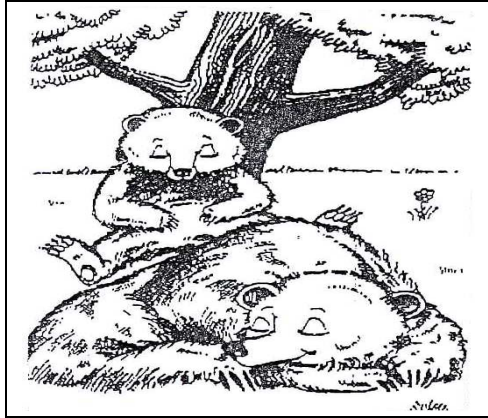

ITEM 10

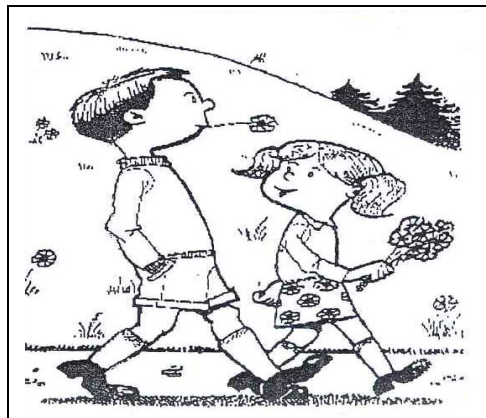
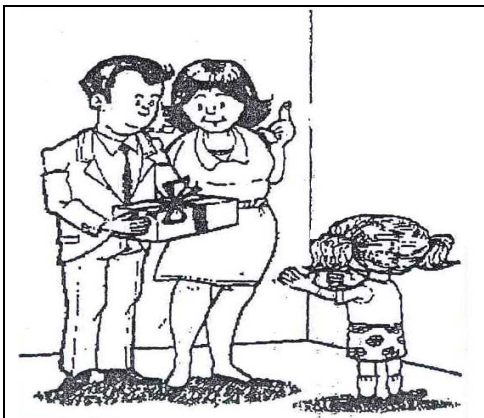
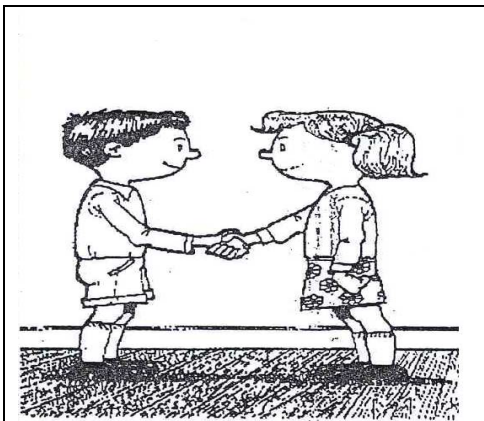

Découvrir le monde
Approcher les quantités et les nombres

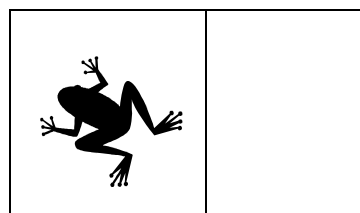
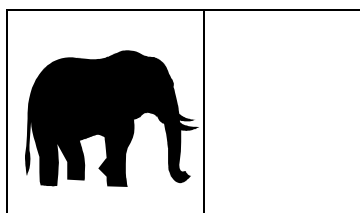
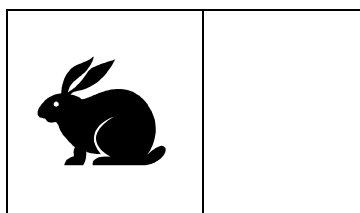
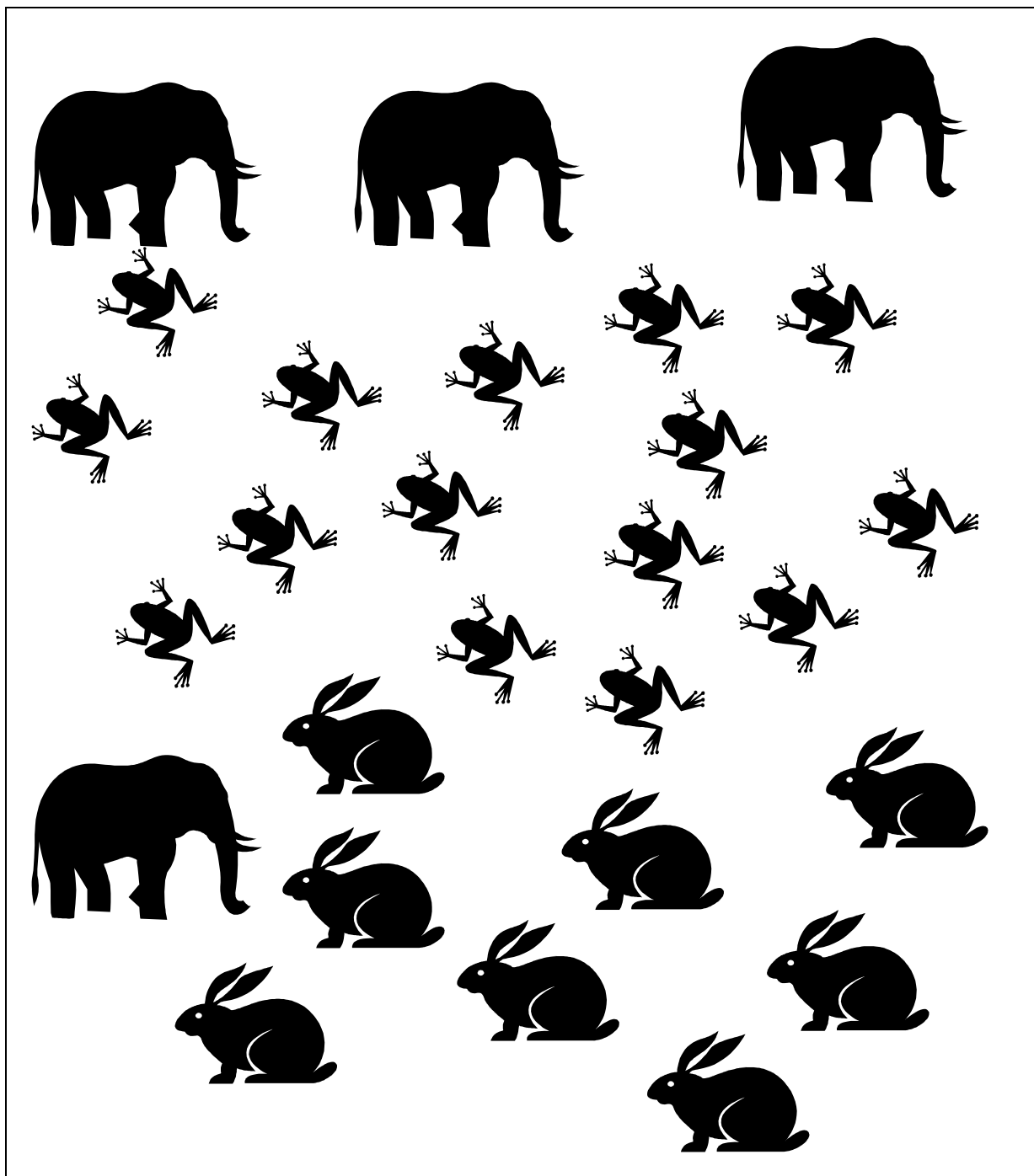



EPREUVE 14

ITEM 1

Je connais la comptine numérique jusqu'à :

ITEM 2

	6	8	9	7	4
---	---	---	---	---	---

	4	1	3	5	6
---	---	---	---	---	---

	2	0	10	9	8
---	---	---	----	---	---

ITEM 3

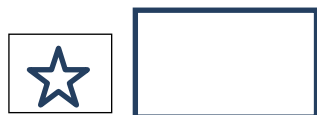
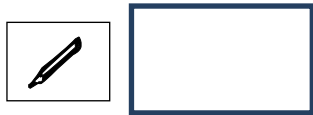
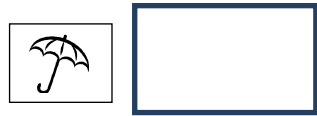
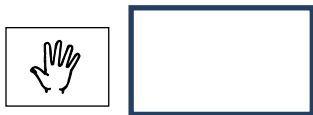
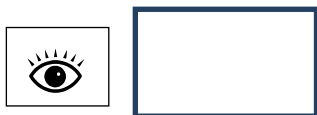

EPREUVE 15

1	2	3	4	5	6	7	8	9	10	11	12	13	14	15	16
---	---	---	---	---	---	---	---	---	----	----	----	----	----	----	----

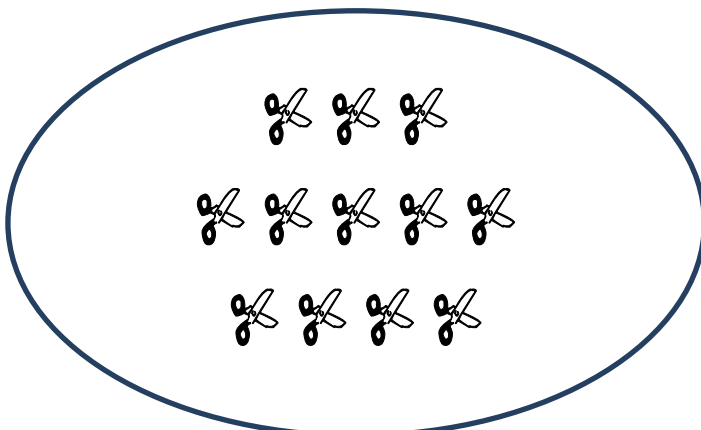
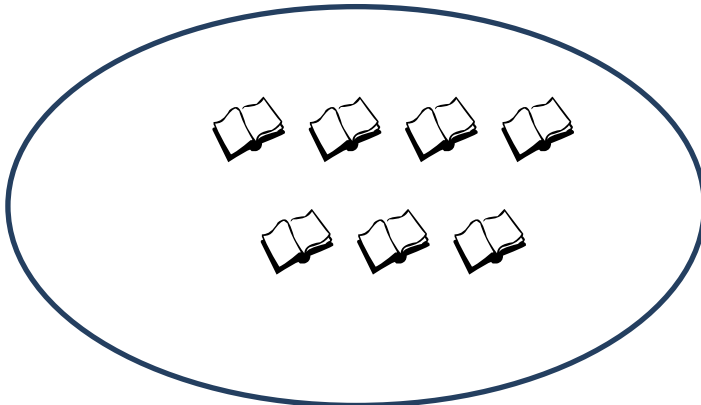
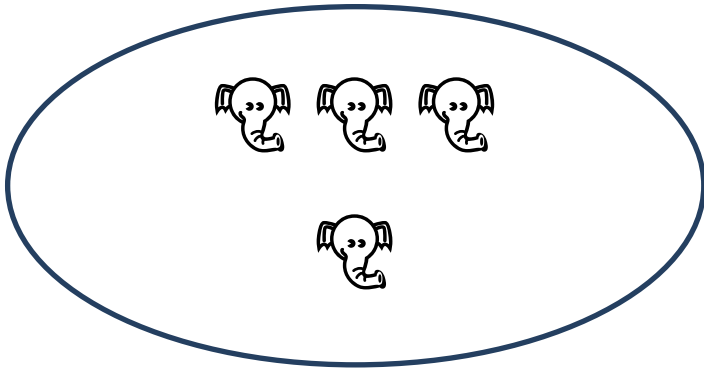
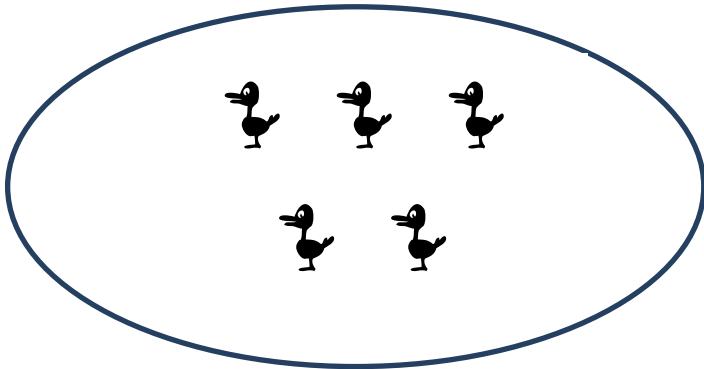

Comparer

ITEM 1 : plus que

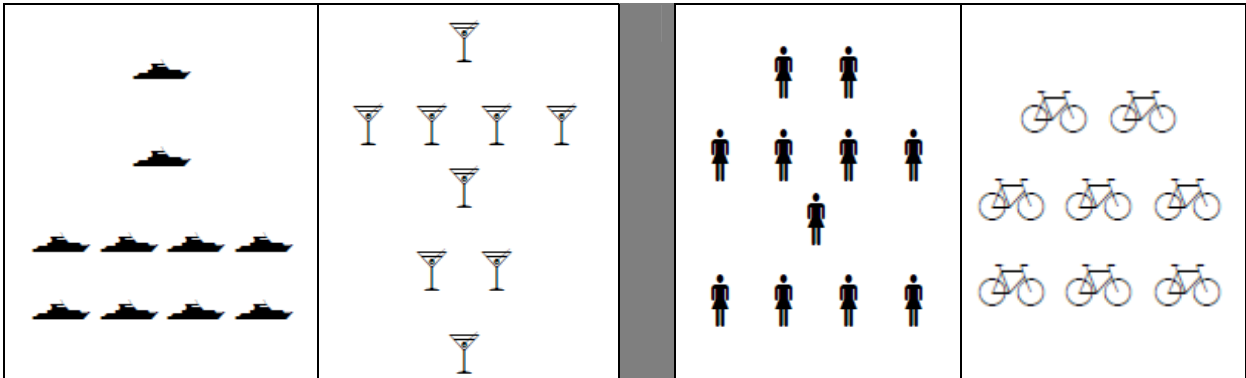

ITEM 2: moins que

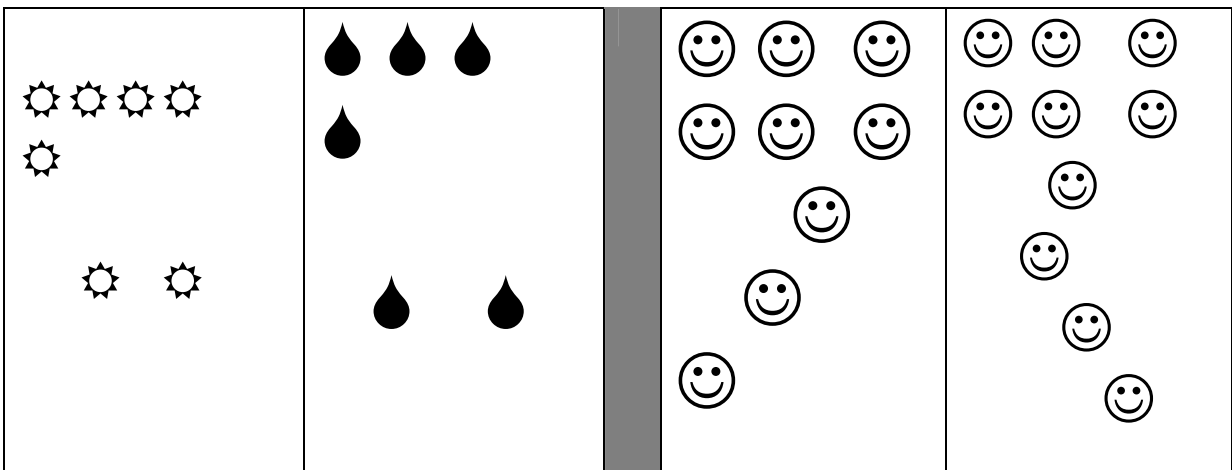

ITEM 3: autant que

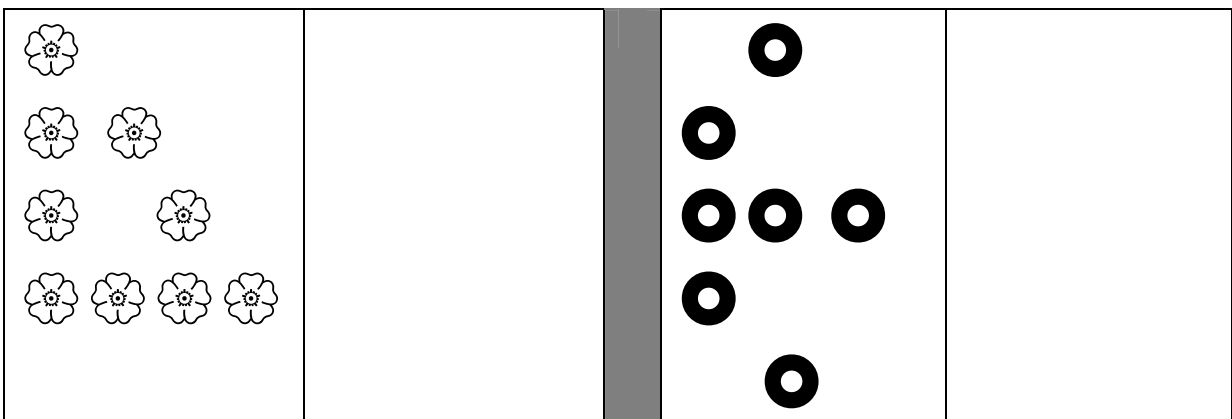

Résoudre des problèmes portant
sur des quantités

ITEM 1



ITEM 2

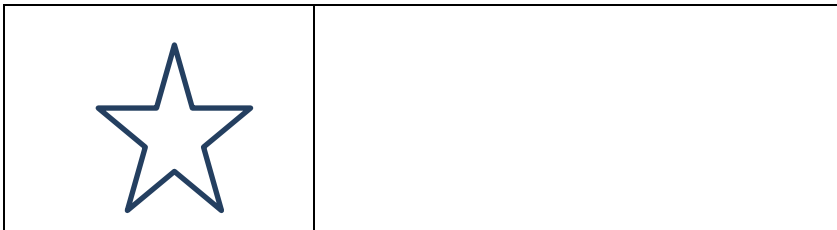

ITEM 3



ITEM 4



EPREUVE 18

ITEM 1

Un rond	Un carré	Un triangle

ITEM 2 : se repérer dans l'espace

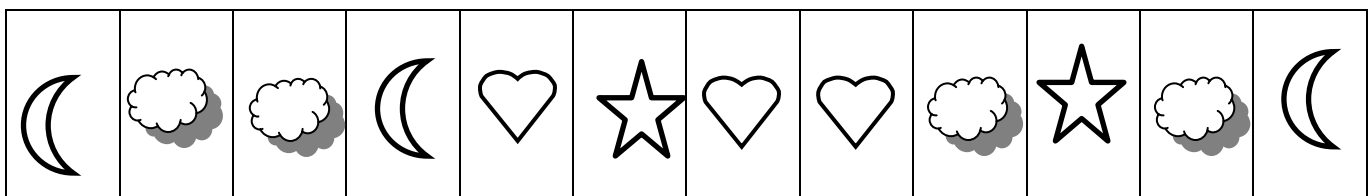
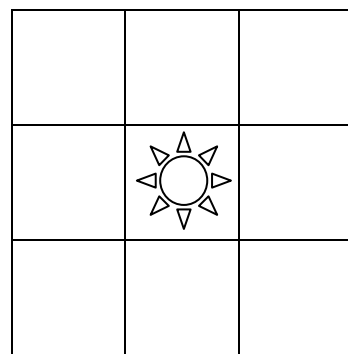
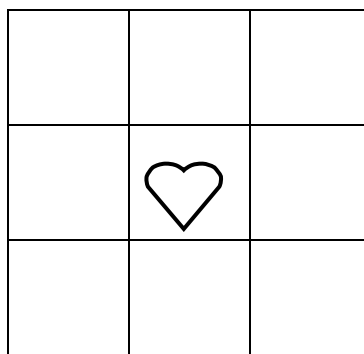
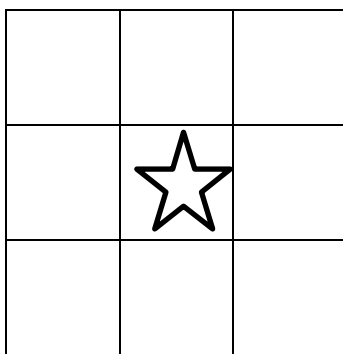

ITEM 3 : se repérer dans le temps

lundi	mardi	mercredi	jeudi	vendredi	samedi	dimanche
-------	-------	----------	-------	----------	--------	----------